

# Knowing Your Kiln

## TECHNOTES 1 | Foundational for Kilnforming Success

To achieve control in firing glass, it is necessary to understand how heat is distributed within the kiln you are using. Kiln heat is rarely even. Top-fired kilns tend to be hotter in the center. Side-fired kilns are frequently hotter around the perimeter. The pyrometer reads only one

point within the kiln chamber and may not give you an accurate indication of the heat treatment the glass is receiving. In working with a new kiln, making a few preliminary tests will help you to understand the kiln's heating patterns and gain better control over your results.

### TESTING THE "LOW END"

At the low end of the temperature range—generally below 1200°F (649°C)—you will be slumping, bending and/or annealing the glass. Understanding heat distribution in this temperature range will be important for two reasons:

**For bending and slumping:** The heat pattern in the kiln will determine how and where to set up the project.

**For annealing:** The heat pattern will determine whether the kiln can properly anneal projects that cover a large area within the kiln chamber. If heat distribution in the kiln is uneven, large projects may break, due to annealing strain.

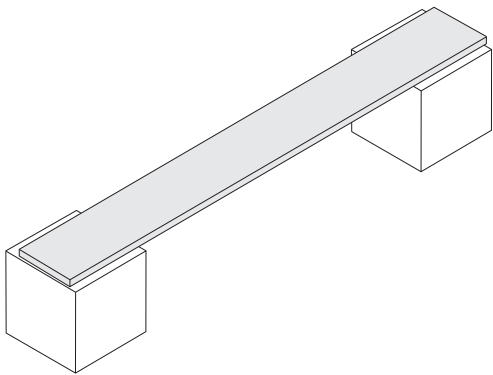

Figure 1

Figure 1 shows a 6" x 3/4" x 1/8" (152mm x 19mm x 3mm) strip of glass suspended over two 1" (25mm) tall mullite blocks. On a 20" (508mm) square kiln shelf, 13 such set-ups should be spaced evenly over the surface of the shelf. Use the same style of glass, preferably all from the same sheet or production date, for all 13 set-ups. (See Figure 2 for arrangement.)

### Fire the kiln, using this schedule.

	RATE	TEMPERATURE	HOLD
1	500°F (278°C)	1000°F (538°C)	:05
2	300°F (167°C)	1150°F (621°C)	:05

Allow kiln to cool below 700°F (371°C) with the door closed. No annealing necessary.

### READING THE RESULTS

If the glass strips around the perimeter are more deeply slumped than those in the center of the kiln, the perimeter is heating more than the center. (Figure 2)

If, instead, the center strips show a greater curve, the center is the area of greater heat work.

If all strips are equally slumped, the kiln is firing evenly.

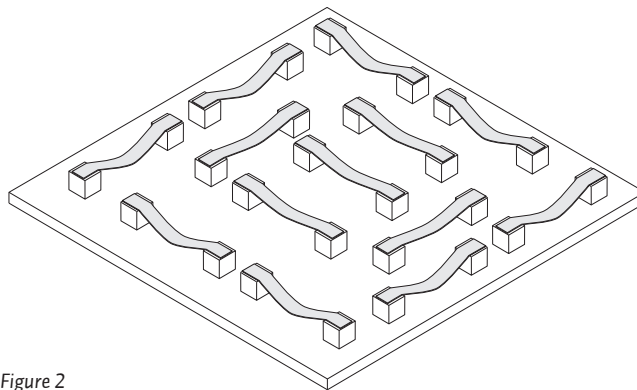

Figure 2

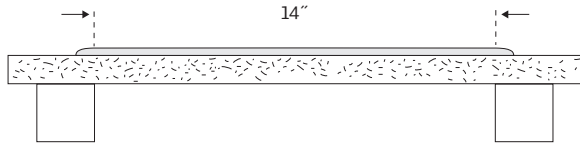

Figure 3

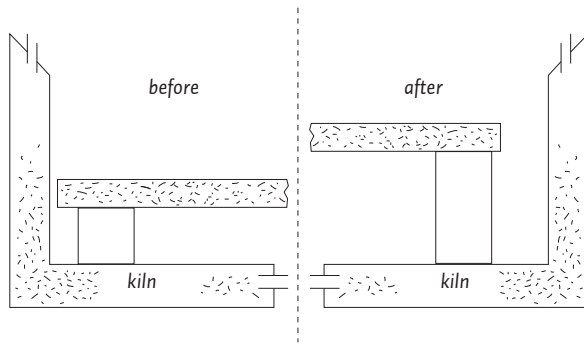

Figure 4

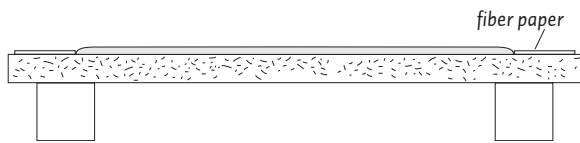

Figure 5

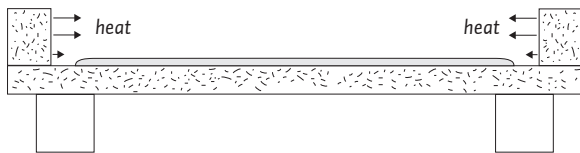

Figure 6

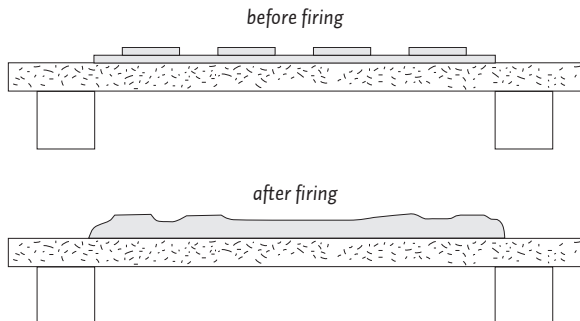

Figure 7

## CORRECTING FOR UNEVEN HEATING

If the test results indicate that your kiln is firing unevenly, you can choose from the following actions to correct the problem:

1. Use a slower firing cycle.
2. Reduce the size of the glass project relative to the size of the kiln shelf. For example, rather than covering the full 20" (508mm) width of a shelf with a piece, limit the dimensions of the piece to 14" (356mm). (Figure 3)
3. Reduce the size of the kiln shelf and raise it further off the kiln floor to allow greater heat circulation around the shelf and the piece. (Figure 4)

If the test results indicate that the outer edges of the kiln are cooler than the center, try the following:

1. Insulate the edges of the glass piece with ceramic fiber paper, blanket, or board. This will slow down heat release from the edges. (Figure 5)
2. Create a perimeter wall of hard brick around the outer edges of the piece. Upon heating, the hard brick will absorb heat. Upon cooling, this absorbed heat will radiate back toward the glass and prevent its edges from cooling too rapidly. (Figure 6)

If the test results show an asymmetrical heating pattern (i.e., some areas along the perimeter of the kiln are hotter relative to the center, while others are colder), the elements within the kiln may not be firing properly. Turn the kiln to full fire and observe the elements. Are they glowing equally? If not, they will need either to be replaced or repositioned.

**Note:** Coiled-wire heating elements, if not properly secured to the kiln walls or ceiling, have a tendency to move, bunching up in corners or at the ends of the elements. The elements also tend to become brittle with prolonged use and may break or weaken if manipulated while cold.

**Caution:** Adjusting kiln elements is best done when the elements are hot (the power having just been disconnected). Such adjustments should be made only by qualified kiln technicians. In some cases, it may be most sensible to replace the elements. Make certain that replacement elements are secured in such a fashion that they are unlikely to move within the element grooves or along the element hangers.

## UNDERSTANDING THE “HIGH END”

At the high end of the temperature range, where fusing occurs, you may get different results within different areas of the kiln, due to:

- The type of kiln (top- or side-fired)
- The type of kiln insulation (brick or refractory fiber)
- Kiln power and rate of heating
- Soak time
- The size of the shelf relative to the size of the kiln.

In a top-fired kiln, the corners or perimeter of the shelf are frequently colder than the center. Since the center of the kiln fires hotter than the edges or corners, the finished piece may have an uneven surface. (Figure 7)

With a side-fired kiln, the opposite is likely to occur. The temperature will be higher around the perimeter of the shelf than in the center. This faster firing at the edges can cause bubbles by trapping air between layers of glass and/or cause thin, ragged edges (“needle-pointing”). (Figures 8, 9)

## FINDING OUT HOW YOUR KILN FIRES AT ITS HIGH END

By using an external, hand-held pyrometer and taking thermocouple readings at the middle and edges of your kiln, you can get a general idea of the heating differential within your kiln. (Figure 10)

You can get a more thorough understanding of your heating differential by performing the following test:

Assemble 5 stacks of test tiles, using Bullseye Clear (001101-0030F), Black (000100-0030F) and White (000113-0030F) glass. The bottom 2 layers should be 3” (76mm) square Clear tiles; the center layer, a 1” x 3” (25mm x 76mm) strip of Black; the next layer, a 1” x 3” (25mm x 76mm) strip of White; and the top layer, a 1/2” (13mm) square Black tile. (Figure 11)

Optional: By placing frits, stringers, or chips of other glass on the corners, you can learn more about the behavior of these materials at full fusing temperatures.

Place the tiles directly on the primed kiln shelf as shown in Figure 12. Do not place the tiles on fiber paper, as they will stick to the fiber and that will influence the test result. (Figure 12)

Fire the kiln at 1490°F (810°C) for 10 minutes, using this cycle:

	RATE	TEMPERATURE	HOLD
1	500°F(278°C)	1000°F (538°C)	:05
2	600°F (333°C)	1490°F (810°C)	:10
3	AFAP*	900°F (482°C)	:30
4	200°F (93°C)	700°F (371°C)	:30
5	AFAP*	70°F (21°C)	:00

\*As fast as possible.

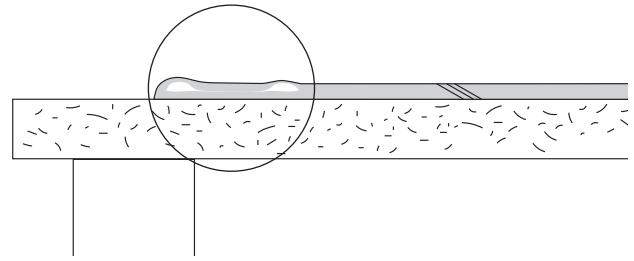

Figure 8: Cutaway showing Bubbles caused by faster fusing of the edges and consequent air entrapment between layers.

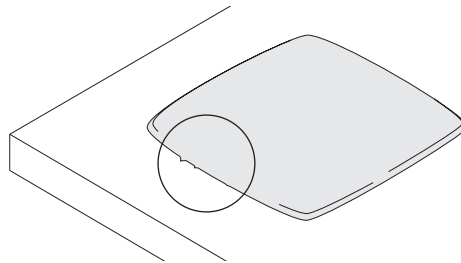

Figure 9: A thin, ragged edge (“needle-pointing”) caused by increased pulling inward at the hotter, outer edges.

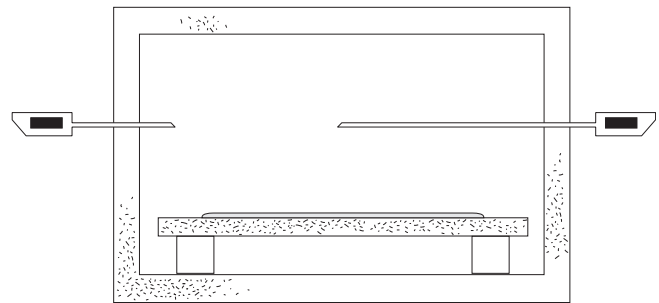

Figure 10

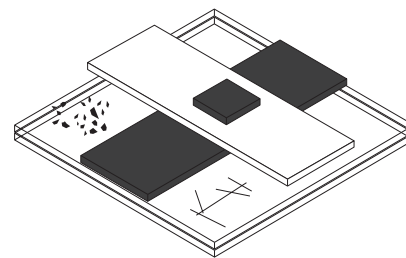

Figure 11

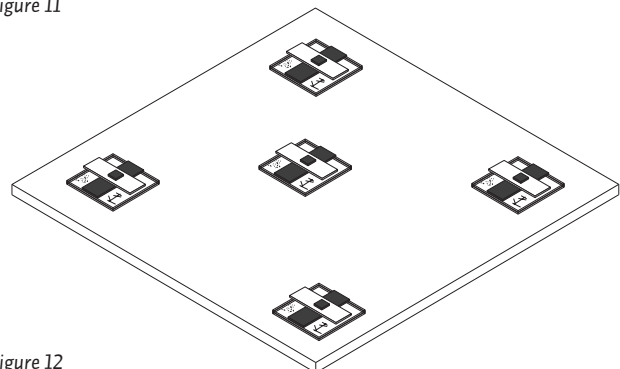

Figure 12

If the fired test tiles all have the same surface—congratulations! You have a kiln that fires evenly.

If, instead, the surfaces of the tiles are not all the same, there are ways to compensate for the variation.

### ADJUSTING FOR UNEVEN FIRING AT THE HIGH END

1. Soaking your project with a longer hold at process temperature will help to even out the temperature differential. To avoid overfiring, you may need to reduce your maximum temperature by 10°F (5°C).
2. To prevent trapping air between layers when firing in a side-fired kiln, insulate or baffle the perimeter of the glass with ceramic fiber paper or brick, and/or consider adding a programmed hold somewhere in the range 1150–1250°F (621–677°C) to “squeeze” out any air from between the layers of glass.
3. Use a dense ceramic shelf. This will conduct heat well, allowing it to penetrate and escape from the bottom of the glass with ease.
4. Use a smaller kiln shelf. This will result in better heat circulation and, consequently, help to even out the temperature.
5. Make sure that your kiln shelf is not sitting on large bricks or strips. Try to minimize the amount of contact between the kiln shelf and its supports. Hollow supports are ideal.
6. Finally, if you are firing a number of different projects on one shelf, arrange them to take advantage of the heating pattern in your kiln. For example, if your kiln fires colder around the perimeter, you may want to put softer glasses to the outside and stiffer glasses to the middle of the shelf.

**Remember:** Understanding your kiln and the way it transfers heat to the glass is a major factor in ensuring the success of your kilnformed projects. If you find discrepancies in how uniformly your kiln heats (and therefore cools), you can make some corrections. Ultimately, however, corrections can only go so far. If your kiln is not firing uniformly, you may want to consider repairing or replacing it. The kiln is the most valuable tool (outside of yourself) that you have in your studio. A kiln that fires unevenly can result in lost time and lost work.

### TEMPERATURE CONVERSION CHART

Use this table to look up a known temperature and find the corresponding temperature in °C or °F. Examples: To convert 100°F to °C, look up 100 in the center column and read the box directly to the left (38°C). To convert 100°C to °F, look up 100 in the center column and read the box directly to the right (212°F).

°C	TEMP	°F	°C	TEMP	°F	°C	TEMP	°F
-12	10	50	210	410	770	432	810	1490
-7	20	68	216	420	788	438	820	1508
-1	30	86	221	430	806	443	830	1526
4	40	104	227	440	824	449	840	1544
10	50	122	232	450	842	454	850	1562
16	60	140	238	460	860	460	860	1580
21	70	158	243	470	878	466	870	1598
27	80	176	249	480	896	471	880	1616
32	90	194	254	490	914	477	890	1634
38	100	212	260	500	932	482	900	1652
43	110	230	266	510	950	488	910	1670
49	120	248	271	520	968	493	920	1688
54	130	266	277	530	986	499	930	1706
60	140	284	282	540	1004	504	940	1724
66	150	302	288	550	1022	510	950	1742
71	160	320	293	560	1040	516	960	1760
77	170	338	299	570	1058	521	970	1778
82	180	356	304	580	1076	527	980	1796
88	190	374	310	590	1094	532	990	1814
93	200	392	316	600	1112	538	1000	1832
99	210	410	321	610	1130	543	1010	1850
104	220	428	327	620	1148	549	1020	1868
110	230	446	332	630	1166	554	1030	1886
116	240	464	338	640	1184	560	1040	1904
121	250	482	343	650	1202	566	1050	1922
127	260	500	349	660	1220	571	1060	1940
132	270	518	354	670	1238	577	1070	1958
138	280	536	360	680	1256	582	1080	1976
143	290	554	366	690	1274	588	1090	1994
149	300	572	371	700	1292	593	1100	2012
154	310	590	377	710	1310	599	1110	2030
160	320	608	382	720	1328	604	1120	2048
166	330	626	388	730	1346	610	1130	2066
171	340	644	393	740	1364	616	1140	2084
177	350	662	399	750	1382	621	1150	2102
182	360	680	404	760	1400	627	1160	2120
188	370	698	410	770	1418	632	1170	2138
193	380	716	416	780	1436	638	1180	2156
199	390	734	421	790	1454	643	1190	2174
204	400	752	427	800	1472	649	1200	2192

### WATCH OUT!

Use the table above only to convert specific temperatures.

**Do not use it to convert heating and cooling rates.** If you apply converted temperatures to a heating or cooling rate, you will always be off between 18° (if moving from F to C) and 32° (if moving from C to F).

For example, if you fire at a rate of 600°F per hour (DFPH) to 1270°, you will arrive at 1270° in 2 hours (2:00). If you use this chart to convert 600°F to 316°C per hour (DCPH) and fire to 688°C, you will arrive at 688°C in 2 hours and 10 minutes (2:10), or 10 minutes slower.

To convert a Fahrenheit rate to centigrade, simply divide the Fahrenheit number by 1.8. Conversely, to change a centigrade rate to Fahrenheit, multiply by 1.8.